

SUDBROCK CUT-Y

TYPENLISTE

gültig ab 01.01.2014

S. 2 - 3	Technische Hinweise / Ausführungen
S. 4 - 6	Vorschläge
S. 7 - 17	Zeilen
S. 18 - 21	Einzelemente
S. 22	TV-Paneele / Rückwände/Abdeckblätter/Sockelplatten
S. 23	Zubehör



Cut-Y

Sideboard mit Zeilensprung

Geringfügige Abweichungen und Änderungen vorbehalten!

Das Design

Verspielt und gleichzeitig sachlich präsentiert sich das Sideboard-Programm Cut-Y: die Nischen der abgeschrägten Korpusmodule bilden einen reizvollen Gegensatz zu den großzügigen Flächen des Möbels.

Licht und Schatten erzeugen auf diesen kleinen Bühnen einen interessanten Effekt, der bei farblich abgesetzten Rückwänden noch intensiver wirkt. Individuelle Gestaltungsmöglichkeiten bieten zudem verschiedene Hölzer und Lackfarben.

Die Griffvarianten

Cut-Y Elemente werden standardmäßig mit Pushbeschlag geliefert.

Das System

Die Zeilenmodule sind in mehreren Höhen und Breiten erhältlich. Sie können beliebig miteinander kombiniert und angeordnet werden. Die Tiefe des Möbels beträgt 40 cm.

Die Zeilen werden durch Abdeckblätter optisch voneinander getrennt. Jede Zeile muss auf der gesamten Länge oben abgedeckt sein. Die maximale Länge eines Abdeckblattes beträgt 3m. Wenn eine Kombination breiter ist, wird ein Abdeckblatt an einer passenden Stelle angesetzt (siehe Pfeil).

Die Abdeckblätter sind preislich im Korpus enthalten und werden automatisch der Zeilenbreite angepasst. Bitte beachten Sie die Abdeckblätter mit Tiefenversprung bei den TV-Paneelen. Die Sockelplatte muss bei Bedarf mitbestellt werden.

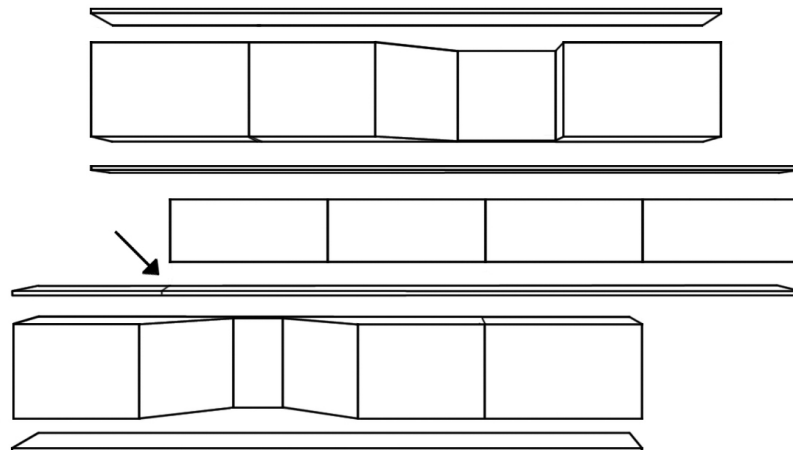

TV-Paneel

Für oben offene Lösungen mit TV-Paneel wird das Abdeckblatt angeschrägt. Diese Lösung ist nicht bei den 25mm starken Rückwänden möglich.

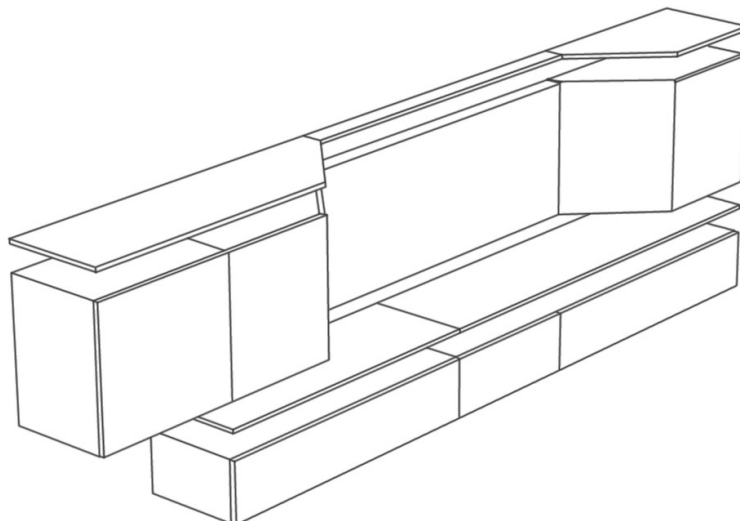

Cut-Y

Die Oberflächen

Für eine Type in Ausführungen aus unterschiedlichen Preisgruppen wird komplett die höhere Preisgruppe berechnet.

Preisgruppe 10

- 103. Wildeiche
- 121. Eiche anthrazit
- 124. Wildeiche coffee

Glattlack

- 419. blütenweiß (RAL 9010)

Preisgruppe 20

- 101. Eiche gekälkt
- 102. Ethno Eiche (astig)

Preisgruppe 20

Glattlack

- 405. muschelgrau
- 407. steingrau
- 408. terra
- 409. magnolia
- 420. verkehrsweiß (RAL 9016)
- 435. schwarzblau
- 437. quarz
- 439. schwarz
- 454. orientrot
- 465. sienna
- 467. bordeaux
- 468. sand
- 474. mocca
- 477. indisch rot
- 490. curry
- 494. canagrau
- 496. superlemon
- 497. laguna

Schrägelemente:

Die Türen der Schrägelemente sind nur in den Lackausführungen lieferbar.

Cut-Y

Vorschläge

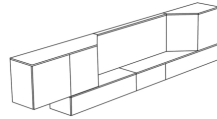

Vorschlag 669

Zeile

PG 10

PG 20

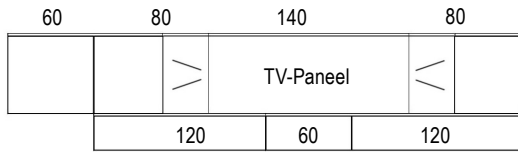

99 (inkl. TV-Paneel)

01 + 14

B / H / T : 360 / 99,4 / 40 cm

Vorschlag 667

Zeile

PG 10

PG 20

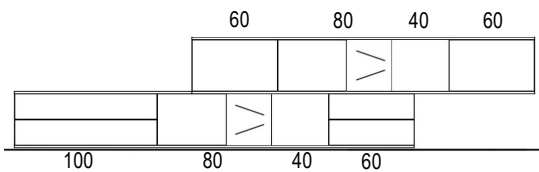

52

81

Art.-Nr. 32378 (Sockelplatte 280cm)

B / H / T : 358 / 78,8 / 40 cm

Vorschlag 837

Zeile

PG 10

PG 20

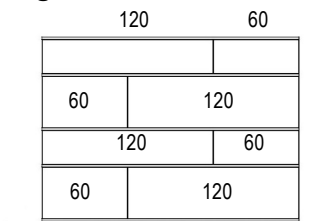

14 gespiegelt

15

14 gespiegelt

15

Art.-Nr. 32374 (Sockelplatte 180cm)

B / H / T : 180 / 130,8 / 40 cm

Vorschlag 838

Zeile

PG 10

PG 20

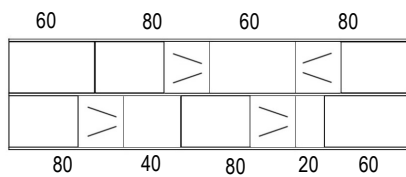

85

89

B / H / T : 280 / 76,7 / 40 cm

Vorschlag 839

Zeile

PG 10

PG 20

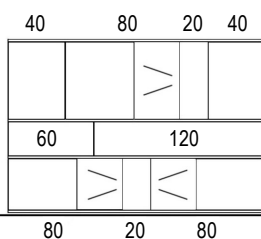

24

14

27

Art.-Nr. 32374 (Sockelplatte 180cm)

B / H / T : 180 / 76,7 / 40 cm

Cut-Y

Vorschläge

Vorschlag 840

Zeile

PG 10

PG 20

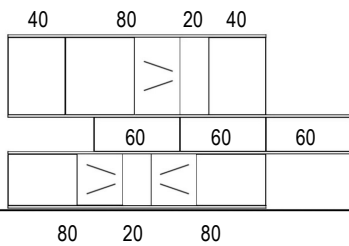

24

16

27

Art.-Nr. 32374 (Sockelplatte 180cm)

B / H / T : 240 / 99,4 / 40 cm

Vorschlag 841

Zeile

PG 10

PG 20

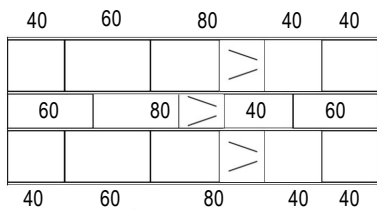

72

63 gespiegelt

72

B / H / T : 260 / 78,8 / 40 cm

Vorschlag 842

Zeile

PG 10

PG 20

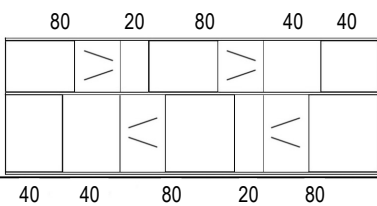

68

77

Art.-Nr. 32377 (Sockelplatte 260cm)

B / H / T : 260 / 76,7 / 40 cm

Vorschlag 843

Zeile

PG 10

PG 20

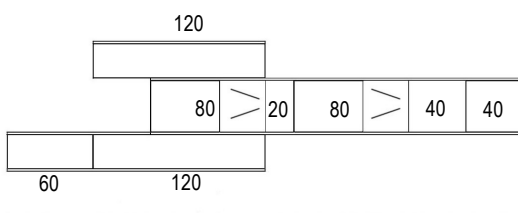

1

68

14

B / H / T : 360 / 87,3 / 40 cm

Vorschlag 844

Zeile

PG 10

PG 20

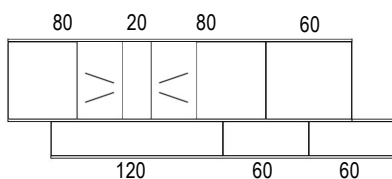

61

49 gespiegelt

B / H / T : 280 / 76,7 / 40 cm

Cut-Y

Vorschläge

Vorschlag 845

Zeile

PG 10

PG 20

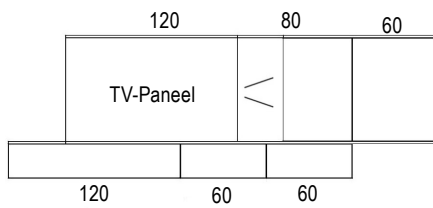

79 (inkl. TV-Paneel)

49 gespiegelt

B / H / T : 300 / 99,4 / 40 cm

Vorschlag 846

Zeile

PG 10

PG 20

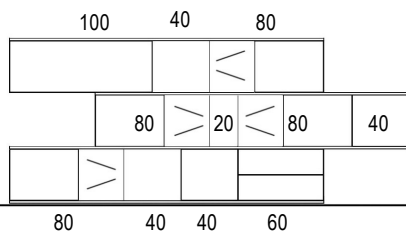

41

44 gespiegelt

37

Art.-Nr. 32376 (Sockelplatte 240cm)

B / H / T : 280 / 78,8 / 40 cm

Vorschlag 696

Zeile

PG 10

PG 20

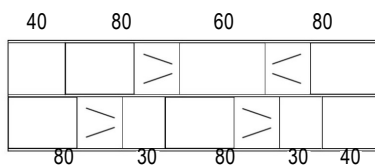

67

32

Art.-Nr. 32367 (Blatt unten 260cm)

B / H / T : 260 / 76,7 / 40 cm

Vorschlag 697

Zeile

PG 10

PG 20

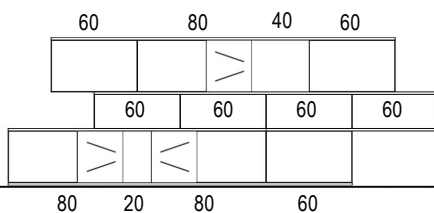

52

47

60

Art.-Nr. 32376 (Sockelplatte 240cm)

B / H / T : 300 / 87,3 / 40 cm

Cut-Y

Zeilen - Breite 120 cm

(Maße zuzügl. Abdeckblätter)

1 Klappe
1 Mittelseite

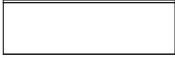

Höhe	2/3 Raster (24 cm)	1 Raster (36,1 cm)
Art.-Nr.	Y01	Y02
bestehend aus Art.-Nr.	38023	38123

PG 10
PG 20

1 Klappe
1 Schubkasten



Höhe	2/3 Raster (24 cm)	1 Raster (36,1 cm)
Art.-Nr.	Y03	Y04
bestehend aus Art.-Nr.	38021	38121
	38031	38131

PG 10
PG 20

1 Tür
2 Schubkästen

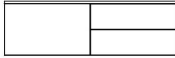

Höhe	1 Raster (36,1 cm) (2 SK)	1,5 Raster (54,1 cm) (3 SK)	2 Raster (72,2 cm) (4 SK)
Art.-Nr.	Y05	Y06	Y07
bestehend aus Art.-Nr.	38112	38212	38312
	38141	38241	38341

PG 10
PG 20

2 Klappen



Höhe	2/3 Raster (24 cm)	1 Raster (36,1 cm)
Art.-Nr.	Y08	Y09
bestehend aus Art.-Nr.	2x 38021	2x 38121

PG 10
PG 20

Cut-Y

Zeilen - Breite 180 cm

(Maße zuzügl. Abdeckblätter)

1 Klappe			
1 Schubkasten			
	Höhe	2/3 Raster (24 cm)	1 Raster (36,1 cm)
	Art.-Nr.	Y14	Y15
	bestehend aus Art.-Nr.	38021	38121
		38033	38133
	PG 10		
	PG 20		

1 Klappe			
2 Schubkästen			
	Höhe	2/3 Raster (24 cm)	1 Raster (36,1 cm)
	Art.-Nr.	Y16	Y17
	bestehend aus Art.-Nr.	38021	38121
		38043	2x 38131
	PG 10		
	PG 20		

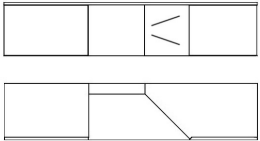
1 Klappe			
1 offenes Fach			
1 Tür (Schrägelement)			
	Höhe	2/3 Raster (24 cm)	1 Raster (36,1 cm)
	Art.-Nr.	Y18	Y19
	bestehend aus Art.-Nr.	38021	38121
		36702	36712
		38080	38180
	PG 10		
	PG 20		

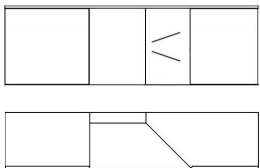
1 Tür			
1 offenes Fach			
1 Tür (Schrägelement)			
	Höhe	1,5 Raster (54,1 cm)	2 Raster (72,2 cm)
	Art.-Nr.	Y20	Y21
	bestehend aus Art.-Nr.	38212	38312
		36722	36732
		38280	38380
	PG 10		
	PG 20		

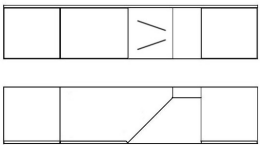
2 Türen			
1 Tür (Schrägelement)			
1 offenes Fach			
	Höhe	2/3 Raster (24 cm)	1 Raster (36,1 cm)
	Art.-Nr.	Y22	Y23
	bestehend aus Art.-Nr.	38010	38110
		38081	38181
		36700	36710
		38011	38111
	PG 10		
	PG 20		

Cut-Y

Zeilen - Breite 180 cm

(Maße zuzügl. Abdeckblätter)

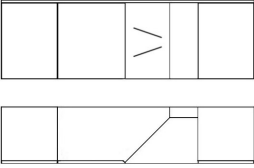
2 Türen	Höhe	1,5 Raster	2 Raster
1 Tür (Schrägelement)		(54,1 cm)	(72,2 cm)
1 offenes Fach	Art.-Nr.	Y24	Y25
	bestehend aus Art.-Nr.	38210	38310
		38281	38381
		36720	36730
		38211	38311
		PG 10	
		PG 20	

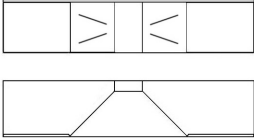
2 Türen (Schrägelemente)	Höhe	2/3 Raster	1 Raster	1,5 Raster	2 Raster
1 offenes Fach		(24 cm)	(36,1 cm)	(54,1 cm)	(72,2 cm)
	Art.-Nr.	Y26	Y27	Y28	Y29
	bestehend aus Art.-Nr.	38080	38180	38280	38380
		36700	36710	36720	36730
		38081	38181	38281	38381
		PG 10			
		PG 20			

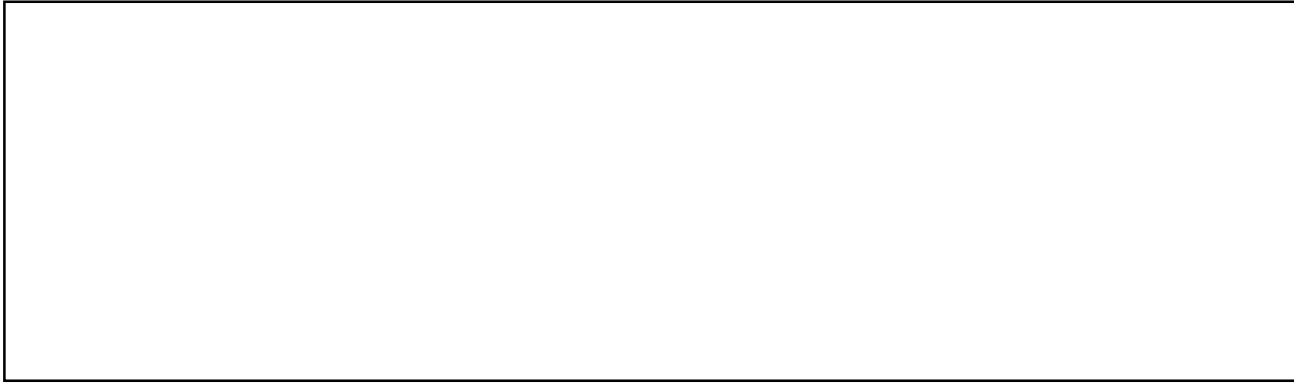
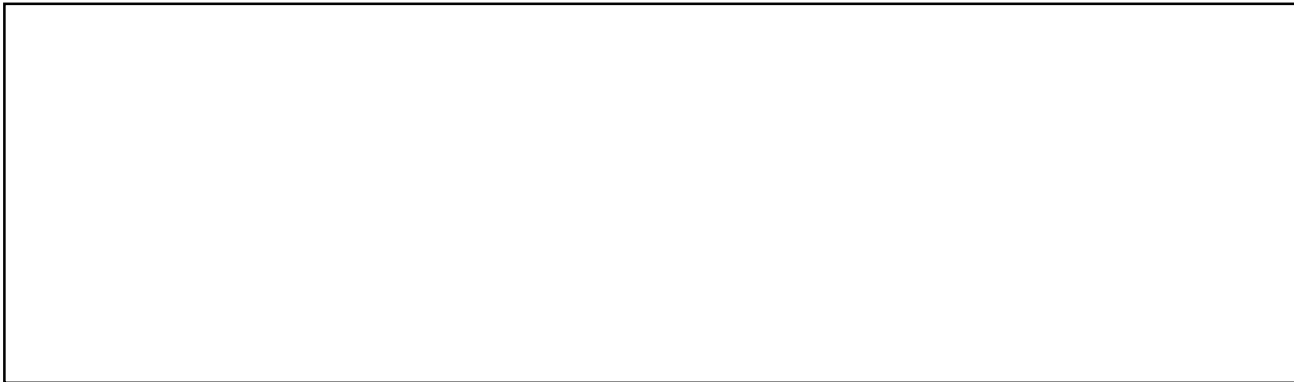





Cut-Y



Zeilen - Breite 220 cm



(Maße zuzügl. Abdeckblätter)

1 Klappe			
2 Schubkästen	Höhe	2/3 Raster (24 cm)	1 Raster (36,1 cm)
	Art.-Nr.	Y30	Y31
	bestehend aus Art.-Nr.	38022	38122
		38043	2x 38131
	PG 10		
	PG 20		

1 Tür (Schrägelement)				
1 offenes Fach	Höhe	1 Raster (36,1 cm)	1,5 Raster (54,1 cm)	2 Raster (72,2 cm)
1 Tür	Art.-Nr.	Y33	Y34	Y35
	bestehend aus Art.-Nr.	38181	38281	38381
		36714	36724	36734
		38113	38213	38313
	PG 10			
	PG 20			

1 Tür (Schrägelement)	Höhe	1 Raster (36,1 cm)	1,5 Raster (54,1 cm)	2 Raster (72,2 cm)
1 offenes Fach				
1 Tür		(2 SK)	(3 SK)	(4 SK)
2 Schubkästen	Art.-Nr.	Y37	Y38	Y39
	bestehend aus Art.-Nr.	38181	38281	38381
		36712	36722	36732
		38111	38211	38311
		38141	38241	38341
	PG 10			
	PG 20			

1 Klappe	Höhe	2/3 Raster (24 cm)	1 Raster (36,1 cm)
1 offenes Fach			
1 Tür (Schrägelement)			(1 GSK)
	Art.-Nr.	Y40	Y41
	bestehend aus Art.-Nr.	38022	38122
		36702	36712
		38080	38180
	PG 10		
	PG 20		

1 Schubkastenelement	Höhe	1,5 Raster (54,1 cm)	2 Raster (72,2 cm)
1 Tür (Schrägelement)			
1 offenes Fach		(3 SK)	(4 SK)
1 Tür	Art.-Nr.	Y42	Y43
	bestehend aus Art.-Nr.	38241	38341
		38281	38381
		36720	36730
		38213	38313
	PG 10		
	PG 20		

Cut-Y

Zeilen - Breite 220 cm

(Maße zuzügl. Abdeckblätter)

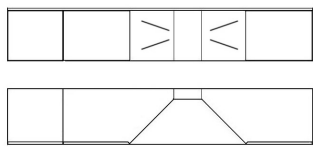
1 Tür	Höhe	1 Raster	1,5 Raster	2 Raster
2 Türen (Schrägelemente)		(36,1 cm)	(54,1 cm)	(72,2 cm)
1 offenes Fach	Art.-Nr.	Y44	Y45	Y46
	bestehend aus Art.-Nr.	38110	38210	38310
		38181	38281	38381
		36710	36720	36730
		38180	38280	38380
		PG 10		
	PG 20			

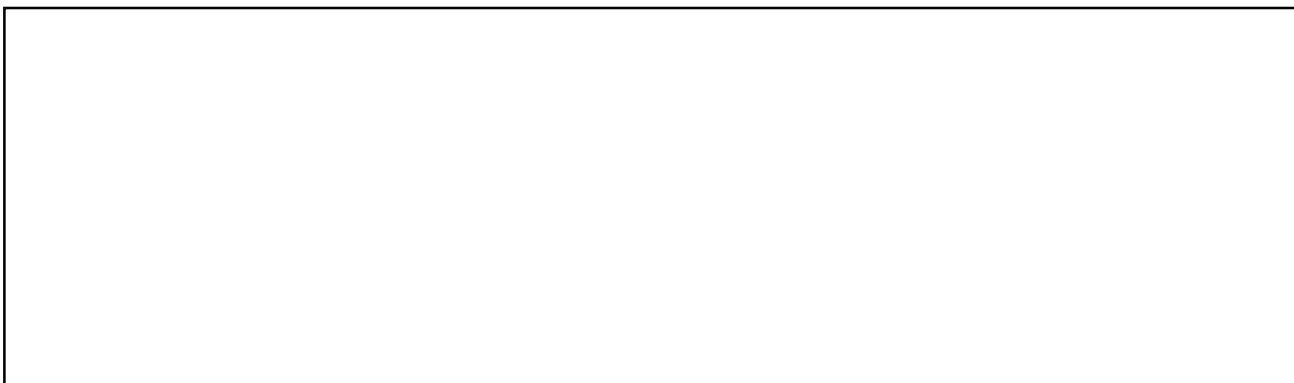

Cut-Y

Zeilen - Breite 240 cm

(Maße zuzügl. Abdeckblätter)

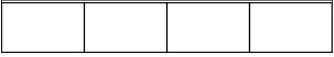
2 Schubkästen			
2 Klappen	Höhe	2/3 Raster (24 cm)	1 Raster (36,1 cm)
	Art.-Nr.	Y47	Y48
	bestehend aus Art.-Nr.	38043	2x 38131
		2x 38021	2x 38121
	PG 10		
	PG 20		

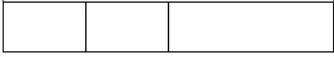
2 Klappen			
1 Schubkasten	Höhe	2/3 Raster (24 cm)	1 Raster (36,1 cm)
	Art.-Nr.	Y49	Y50
	bestehend aus Art.-Nr.	2x 38021	2x 38121
		38033	38133
	PG 10		
	PG 20		

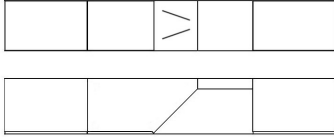
2 Türen	Höhe	2/3 Raster (24 cm)	1 Raster (36,1 cm)
1 Tür (Schrägelement)	Art.-Nr.	Y51	Y52
1 offenes Fach	bestehend aus Art.-Nr.	38012	38112
		38081	38181
		36702	36712
		38013	38113
	PG 10		
	PG 20		

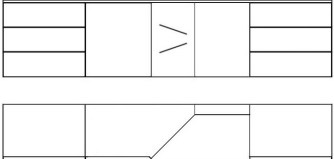
2 Schubkastenelemente	Höhe	1,5 Raster (54,1 cm)	2 Raster (72,2 cm)
1 Tür (Schrägelement)		(2x 3 SK)	(2x 4 SK)
1 offenes Fach	Art.-Nr.	Y53	Y54
	bestehend aus Art.-Nr.	2x 38241	2x 38341
		38281	38381
		36722	36732
	PG 10		
	PG 20		

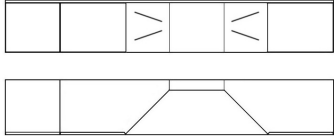
1 Tür	Höhe	1 Raster (36,1 cm)	1,5 Raster (54,1 cm)	2 Raster (72,2 cm)
2 Türen (Schrägelemente)	Art.-Nr.	Y56	Y57	Y58
1 offenes Fach	bestehend aus Art.-Nr.	38110	38210	38310
		38181	38281	38381
		36712	36722	36732
		38180	38280	38380
	PG 10			
	PG 20			

Cut-Y

Zeilen - Breite 240 cm

(Maße zuzügl. Abdeckblätter)

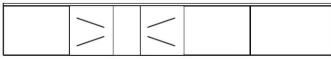
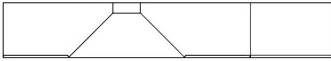
2 Türen (Schrägelemente)	Höhe	1 Raster	1,5 Raster	2 Raster
1 offenes Fach		(36,1 cm)	(54,1 cm)	(72,2 cm)
1 Tür	Art.-Nr.	Y60	Y61	Y62
	bestehend aus Art.-Nr.	38181	38281	38381
		36710	36720	36730
		38180	38280	38380
		38113	38213	38313
	PG 10			
	PG 20			

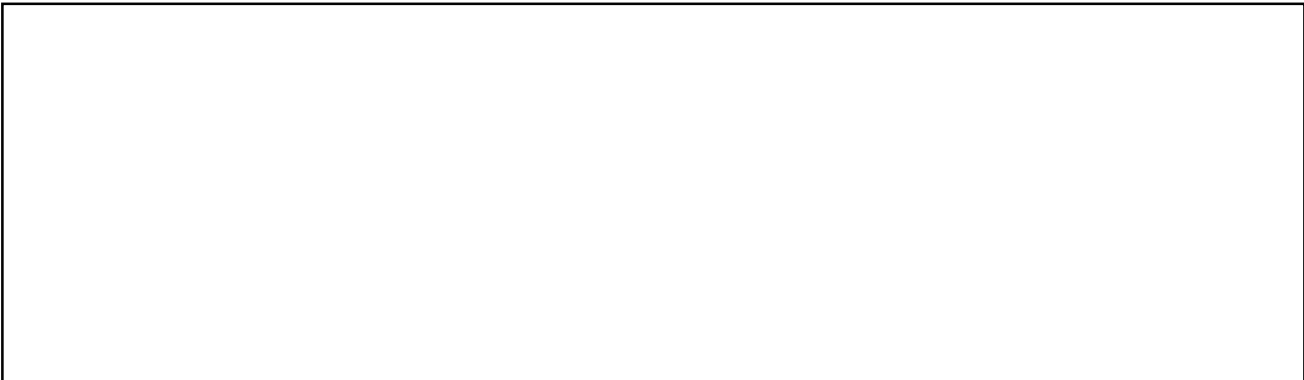
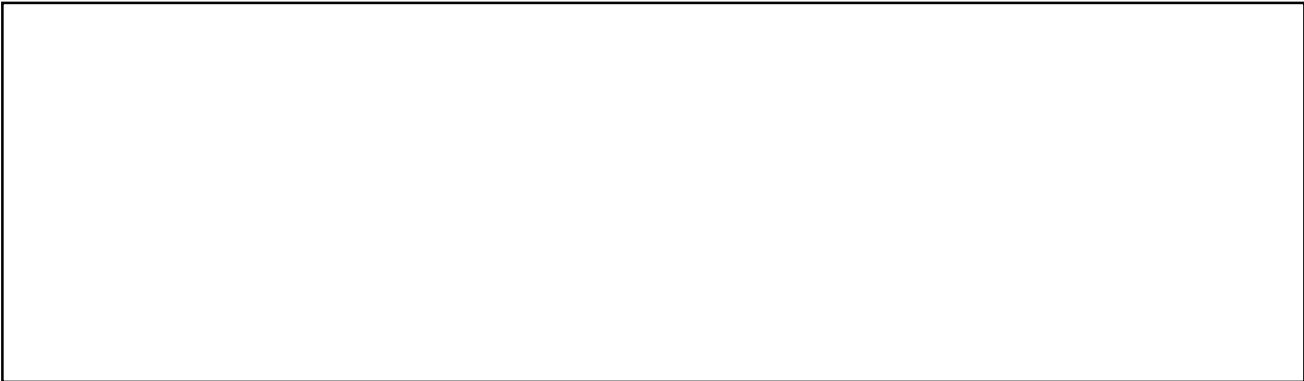



Cut-Y

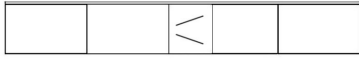
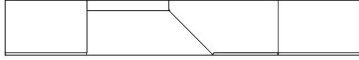

Zeilen - Breite 260 cm

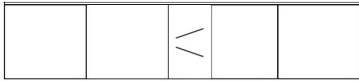
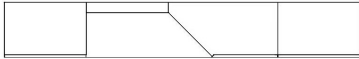
(Maße zuzügl. Abdeckblätter)

2 Schubkästen				
1 offenes Fach	Höhe	2/3 Raster	1 Raster	
1 Tür (Schrägelement)		(24 cm)	(36,1 cm)	
	Art.-Nr.	Y63	Y64	
	bestehend aus Art.-Nr.	2x 38031	2x 38131	
		36703	36713	
		38080	38180	
	PG 10			
	PG 20			

2 Türen	Höhe	1,5 Raster	2 Raster	
1 offenes Fach		(54,1 cm)	(72,2 cm)	
1 Tür (Schrägelement)	Art.-Nr.	Y65	Y66	
	bestehend aus Art.-Nr.	38212	38312	
		36723	36733	
		38280	38380	
		38213	38313	
	PG 10			
	PG 20			

2 Türen (Schrägelemente)	Höhe	1 Raster	1,5 Raster	2 Raster
2 offene Fächer		(36,1 cm)	(54,1 cm)	(72,2 cm)
1 Tür	Art.-Nr.	Y68	Y69	Y70
	bestehend aus Art.-Nr.	2x 38181	2x 38281	2x 38381
		36710	36720	36730
		36712	36722	36732
		38111	38211	38311
	PG 10			
	PG 20			

3 Türen	Höhe	1 Raster	1,5 Raster	2 Raster
1 Tür (Schrägelement)		(36,1 cm)	(54,1 cm)	(72,2 cm)
1 offenes Fach	Art.-Nr.	Y72	Y73	Y74
	bestehend aus Art.-Nr.	38110	38210	38310
		38112	38212	38312
		38181	38281	38381
		36712	36722	36732
		38111	38211	38311
	PG 10			
	PG 20			

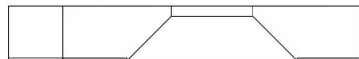
1 Tür	Höhe	1 Raster	1,5 Raster	2 Raster
2 Türen (Schrägelemente)		(36,1 cm)	(54,1 cm)	(72,2 cm)
1 offenes Fach	Art.-Nr.	Y67	Y71	Y75
	bestehend aus Art.-Nr.	38110	38210	38310
		38181	38281	38381
		36713	36723	36733
		38180	38280	38380
	PG 10			
	PG 20			

Cut-Y

Zeilen - Breite 260 cm

(Maße zuzügl. Abdeckblätter)

2 Türen (Schrägelement)

2 offene Fächer

1 Tür

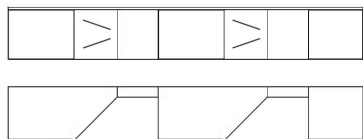

	Höhe	1 Raster	1,5 Raster	2 Raster
		(36,1 cm)	(54,1 cm)	(72,2 cm)
Art.-Nr.		Y32	Y36	Y55
bestehend aus Art.-Nr.		2x 38181	2x 38281	2x 38381
		2x 36711	2x 36721	2x 36731
		38111	38211	38311

PG 10

PG 20

1 Tür

2 offene Fächer

2 Türen (Schrägelemente)

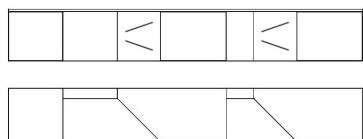

	Höhe	1 Raster	1,5 Raster	2 Raster
		(36,1 cm)	(54,1 cm)	(72,2 cm)
Art.-Nr.		Y76	Y77	Y78
bestehend aus Art.-Nr.		38110	38210	38310
		36712	36722	36732
		36710	36720	36730
		2x 38180	2x 38280	2x 38380

PG 10

PG 20

1 TV-Paneel

1 Tür (Schrägelement)

1 Tür

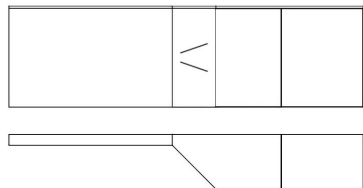

	Höhe	2 Raster
		(72,2 cm)
Art.-Nr.		Y79
bestehend aus Art.-Nr.		26833
		38380
		38313

PG 10

PG 20

Cut-Y

Zeilen - Breite 280 cm

(Maße zuzügl. Abdeckblätter)

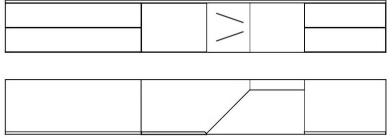
2x 2 Schubkästen	Höhe	1 Raster	1,5 Raster	2 Raster
1 Tür (Schrägelement)		(36,1 cm)	(54,1 cm)	(72,2 cm)
1 offenes Fach		(2x 2 SK)	(2x 3 SK)	(2x 4 SK)
	Art.-Nr.	Y81	Y82	Y83
	bestehend aus Art.-Nr.	38142	38242	38342
		38181	38281	38381
		36712	36722	36732
		38141	38241	38341
	PG 10			
	PG 20			

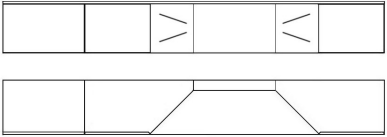
1 Klappe	Höhe	2/3 Raster	1 Raster
2 Türen (Schrägelemente)		(24 cm)	(36,1 cm)
1 offenes Fach	Art.-Nr.	Y84	Y85
	bestehend aus Art.-Nr.	38021	38121
		38080	38180
		38081	38181
		36703	36713
	PG 10		
	PG 20		

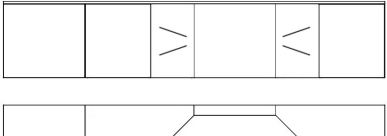
1 Tür	Höhe	1,5 Raster	2 Raster
2 Türen (Schrägelemente)		(54,1 cm)	(72,2 cm)
1 offenes Fach	Art.-Nr.	Y86	Y87
	bestehend aus Art.-Nr.	38212	38312
		38280	38380
		38281	38381
		36723	36733
	PG 10		
	PG 20		

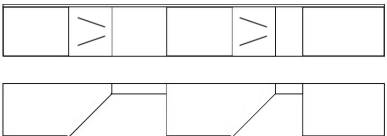
2 Türen (Schrägelemente)	Höhe	2/3 Raster	1 Raster
2 offene Fächer		(24 cm)	(36,1 cm)
1 Schubkasten	Art.-Nr.	Y88	Y89
	bestehend aus Art.-Nr.	2x 38081	2x 38181
		38031	38131
		36702	36712
		36700	36710
	PG 10		
	PG 20		

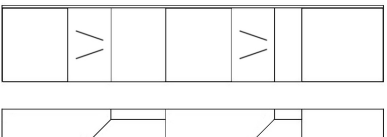
2 Türen (Schrägelemente)	Höhe	1,5 Raster	2 Raster
2 offene Fächer		(54,1 cm)	(72,2 cm)
1 Tür	Art.-Nr.	Y90	Y91
		2x 38281	2x 38381
		36722	36732
		36720	36730
		38213	38313
	PG 10		
	PG 20		

Cut-Y

Zeilen - Breite 280 cm

(Maße zuzügl. Abdeckblätter)

1 Tür (Schrägelement)	Höhe	1 Raster	1,5 Raster	2 Raster
1 offenes Fach		(36,1 cm)	(54,1 cm)	(72,2 cm)
1 Tür	Art.-Nr.	Y93	Y94	Y95
	bestehend aus Art.-Nr.	38181	38281	38381
		38113	38213	38313
		36717	36727	26834 *
	PG 10			
	PG 20			

Zeilen - Breite 360 cm

1 Tür	Höhe	1 Raster	1,5 Raster	2 Raster
2 Türen (Schrägelemente)		(36,1 cm)	(54,1 cm)	(72,2 cm)
1 offenes Fach	Art.-Nr.	Y97	Y98	Y99
	bestehend aus Art.-Nr.	38112	38212	38312
		38180	38280	38380
		38181	38281	38381
		36717	36727	26834 *
	PG 10			
	PG 20			

* Inklusive TV-Paneel.

1 Tür



Breite	40 cm	60 cm
Art.-Nr.	38010 li	38012 li
	38011re	38013re

PG 10
PG 20

Bitte Türanschlag angeben

1 Klappe



Breite	60 cm	100 cm	120 cm
		(1 Mittelseite)	(1 Mittelseite)
Art.-Nr.	38021	38022	38023

PG 10
PG 20

1 Schubkasten



Breite	60 cm	100 cm	120 cm
		(1 Traverse)	(SK geteilt innen 1 Mittelseite)
Art.-Nr.	38031	38032	38033

PG 10
PG 20

2 Schubkästen



Breite	120 cm
	(1 Mittelseite)
Art.-Nr.	38043

PG 10
PG 20

1 Tür (Schrägelement)



Breite	80 cm
Art.-Nr.	38080 li
	38081re

PG 10
PG 20

Bitte beachten Sie, dass die Schräge nicht außen in der Zeile geplant werden kann.

Abb. rechts, Türanschlag links

1 Tür



Breite	40 cm	60 cm
Art.-Nr.	38110 li	38112 li
	38111re	38113 re

PG 10
PG 20

Bitte Türanschlag angeben

1 Klappe



Breite	60 cm	100 cm	120 cm
		(1 Mittelseite)	(1 Mittelseite)
Art.-Nr.	38121	38122	38123

PG 10
PG 20

1 Schubkasten



Breite	60 cm	100 cm	120 cm
		(1 Traverse)	(SK geteilt innen 1 Mittelseite)
Art.-Nr.	38131	38132	38133

PG 10
PG 20

2 Schubkästen

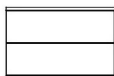

Breite	60 cm	100 cm	120 cm
		(1 Traverse)	(SK geteilt innen 1 Mittelseite)
Art.-Nr.	38141	38142	38143

PG 10
PG 20

1 Tür (Schrägelement)

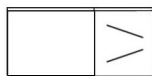

Breite	80 cm
Art.-Nr.	38180 li
	38181re

PG 10
PG 20

Bitte beachten Sie, dass die Schräge nicht außen in der Zeile geplant werden kann.

Abb. rechts, Türanschlag links

1 Tür

1 Einlegeboden

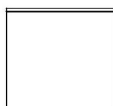

Breite	40 cm	60 cm
Art.-Nr.	38210 li	38212 li
	38211 re	38213 re

PG 10

PG 20

Bitte Türanschlag angeben

3 Schubkästen

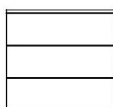

Breite	60 cm	100 cm	120 cm
		(1 Traverse)	(SK geteilt innen 1 Mittelseite)
Art.-Nr.	38241	38242	38243

PG 10

PG 20

1 Tür (Schrägelement)

1 Einlegeboden

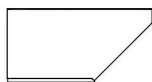
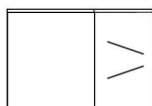

Breite	80 cm
Art.-Nr.	38280 li
	38281 re

PG 10

PG 20

Bitte beachten Sie, dass die Schräge nicht außen
in der Zeile geplant werden kann.

Abb. rechts, Türanschlag links

1 Tür

1 Einlegeboden



Breite	40 cm	60 cm
Art.-Nr.	38310 li	38312 li
	38311re	38313 re

PG 10

PG 20

Bitte Türanschlag angeben

4 Schubkästen

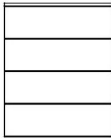

Breite	60 cm	100 cm	120 cm
		(1 Traverse)	(SK geteilt innen 1 Mittelseite)
Art.-Nr.	38341	38342	38343

PG 10

PG 20

1 Tür (Schrägelement)

1 Einlegeboden

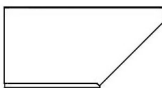
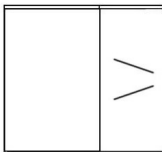

Breite	80 cm
Art.-Nr.	38380 li
	38381re

PG 10

PG 20

**Bitte beachten Sie, dass die Schräge nicht außen
in der Zeile geplant werden kann.**

Abb. rechts, Türanschlag links

Cut-Y

Paneele / Rückwände / Sockelplatten / Abdeckblätter

Rückwände	Breite	20 cm	30 cm	40 cm	60 cm	80 cm	100 cm	120 cm	140 cm
Höhe	Art.-Nr.	36700	36701	36702	36703	36704	36705	36706	36707
2/3 Raster 24,0 cm hoch	PG 10 PG 20								
Art.-Nr.	36710	36711	36712	36713	36714	36715	36716	36717	
1 Raster 36,1 cm hoch	PG 10 PG 20								
Art.-Nr.	36720	36721	36722	36723	36724	36725	36726	36727	
1,5 Raster 54,1 cm hoch	PG 10 PG 20								
Art.-Nr.	36730	36731	36732	36733	36734	36735	36736	36737	
2 Raster 72,2 cm hoch	PG 10 PG 20								

TV Paneele

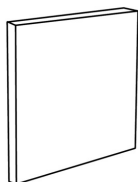

	Breite bis	120 cm	140 cm
	Höhe		
Gesamtiefe 7,3 cm	2 Raster 72,2 cm hoch	Art.-Nr. PG 10 PG 20	26833 26834

Abdeckblatt

16 mm stark

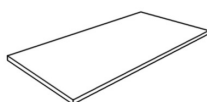

	Breite bis	40 cm	60 cm	120 cm	160 cm	180 cm	200 cm	240 cm	260 cm	300 cm
Tiefe	Art.-Nr.	32360	32361	32362	32363	32364	32365	32366	32367	32368
40 cm	PG 10 PG 20									

Sockelplatte

16 mm stark

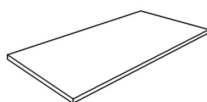

	Breite bis	40 cm	60 cm	120 cm	160 cm	180 cm	200 cm	240 cm	260 cm	300 cm
Tiefe	Art.-Nr.	32370	32371	32372	32373	32374	32375	32376	32377	32378
40 cm	PG 10 PG 20									

Cut-Y

Zubehör

LED-Beleuchtung



1 LED-Leuchte Art.-Nr. 27218

EEK A+ (Halemeier, L 148)

1 Trafo (15 Watt) Art.-Nr. 27220

An 1 Trafo können bis zu 6 LED-Leuchten angeschlossen werden.

Standardmäßig erfolgt die Schaltung durch einen außen liegenden Fußschalter.

Einkanal - Funkfernbedienung



Art.-Nr. 27700

Standardmäßig erfolgt die Schaltung durch einen außen liegenden Fußschalter.
Als Alternative ist auch eine Fernbedienung möglich.

Tipp-Tronic

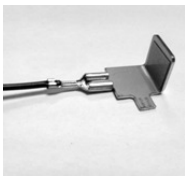

Standardmäßig erfolgt die Schaltung durch einen außen liegenden Fußschalter. Als Alternative ist aber auch eine Tipp Tronic möglich, für die ein Aufpreis berechnet wird. Durch Berühren des Tipp Tronic-Sensors (alu-farbig, Ø 1,5 cm) ist ein Ein- und Ausschalten der gesamten Beleuchtungskörper möglich (230 V, bis 250 W).

Montage bauseits Art.-Nr. 27600

Lieferung lose - Montage erfolgt bauseits. Als Schaltfläche / Kontaktfläche wird ein verchromter Winkel mit dem Kabel der Tipp Tronic-Komponente verbunden und von hinten am Möbel angebracht, so dass ein ca. daumennagelgroßes Plättchen als Schaltfläche sichtbar bleibt.

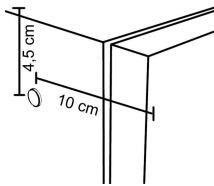

Montage werkseitig Art.-Nr. 27605

Gegen Aufpreis kann die Tipp-Tronic bereits werkseitig montiert werden. Hierbei wird eine verchromte runde (D=8mm) Schaltfläche in eine Bohrung eingebracht und die Schallleitung hinter das Möbel geführt. Die Positionierung erfolgt auf der Höhe des obersten Griffes (max. 3R) und ist 10 cm von der Front nach hinten versetzt.

Einlegeboden

19 mm stark

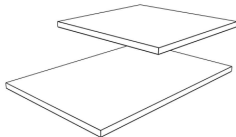

für Breite 40 cm 60 cm 100 cm
(2x 50 cm)

Art.-Nr. 37284 37286 37288

PG 10

PG 20

Einlegeboden für Schrägelement

19 mm stark

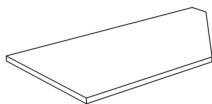

Art.-Nr. 37289

PG 10

PG 20

TV Vorbereitung 5

für Elemente mit einem 1/2 Raster oder 2/3 Raster Fach (maximale Breite 80 cm)



Art.-Nr. 27835

PG 10

bestehend aus: Rückwandblende mit Magnethalterung
Bohrung mittig in der Rückwand

